

Y E182481

RoHS compliant

REV	DESCRIPTION	DATE

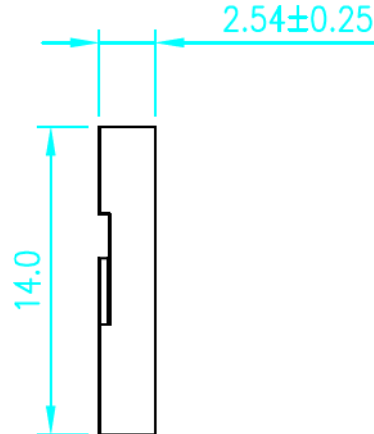
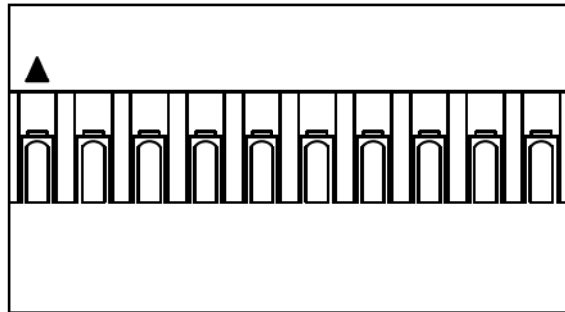
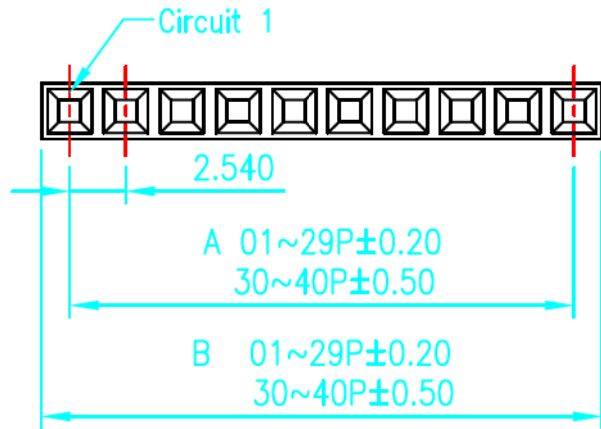

Features:

- * Available in 01 through 40 Circuits
- * Material:P.B.T+15% UL94V-0 or Nylon66 UL94V-0
- * Accepts YY-1800-TF or YY-1900-T or YY-1800-TM Crimp Terminal
- * Mates with YY-1800-WXXS or YY-1800-WXXR Series Header

Ordering information:

YY-1800-HXXX - X
 1 2 3 4

- 1 H=Housing
- 2 No. of Circuits 01~40
- 3 :P.B.T+15%
N:Nylon66 UL94V-0
- 4 Color: :Black E:Yellow I:Gray
 B:Brown F:Green J:White
 C:Red G:Blue K:Pink
 D:Orange H:Purple



Circuits	Dimension mm	
	A	B
1X1	2.54	2.54
1X2	2.54	5.08
A: 2.54 X (PART NO. OF PIN-1) B: 2.54 X (PART NO. OF PIN)		
1X40	99.06	101.60

TOLERANCE	
X.	—
X.X	±0.25
X.XX	±0.15
X.XXX	±0.05
ANGULAR	—



Young Yak Enterprise Co.,Ltd.

TITLE
2.54mm (.100") Pitch Single Row Housing

APPROVALS		VIEW	SCALE	PART NO.	REV.
DRAWN	Terry		F	YY-1800-HXXX-X	AO
CHECKED	Gang				
APPROVED	Song	UNIT	SIZE	DWG NO.	SHEET
		mm	A4	P-1800-H-001	1 OF 1



C **YI** US E182481

REV	DESCRIPTION	DATE
A1	EN980703-2	2009.07.03

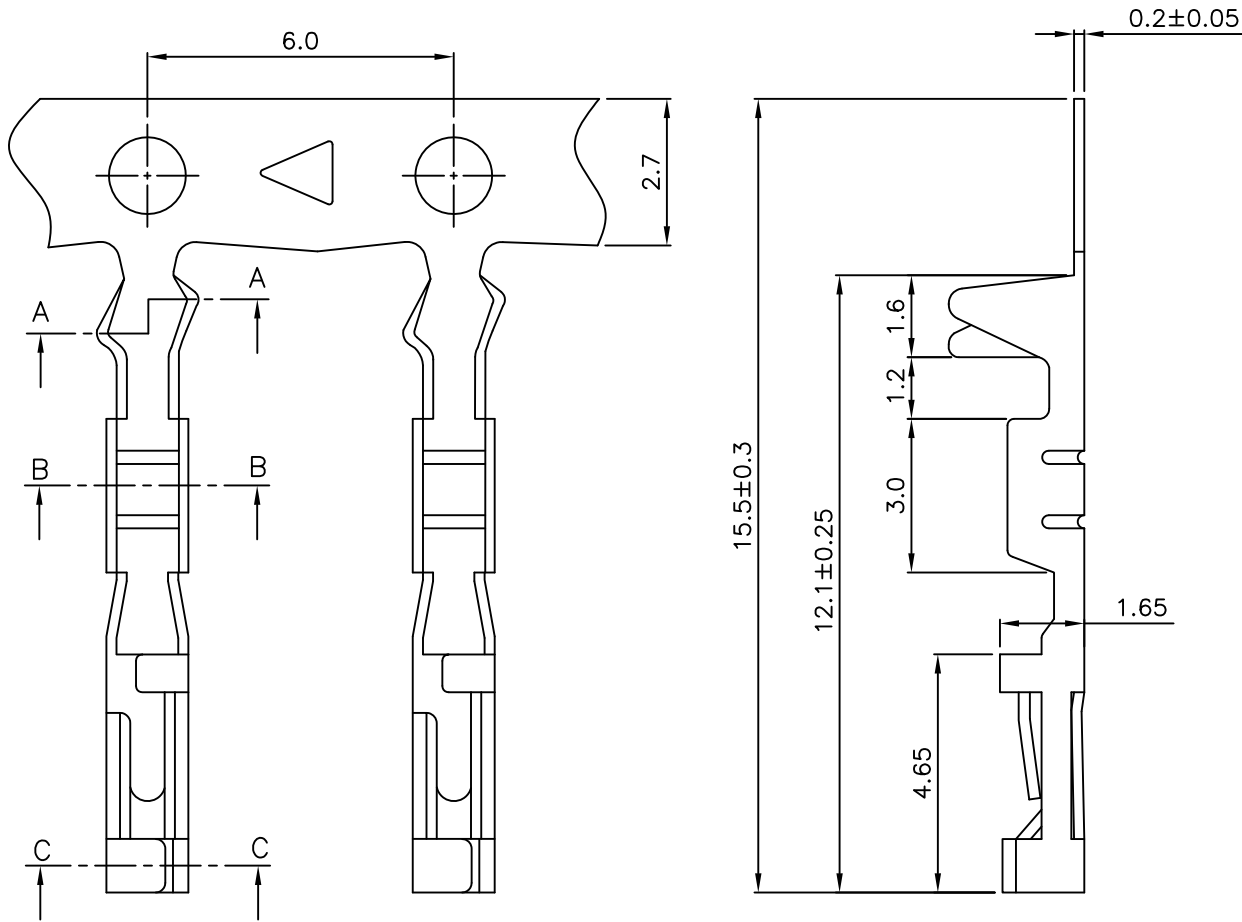

NOTES

Used in YY-1800-H & YY-1900-H
& YY-1920-H Series Housing
(01~19 Pin are available)
Accepts AWG #22~28 Wire Range
Insulation O.D.= 1.70mm(max)
Material : Brass or Phosphor bronze
Finished : Gold-Plated
Qty/Reel : 10,000 PCS
Thickness: 0.2mm

ORDERING INFORMATION

YY-1800 - T F GB *
1 2 3 4

- 1. T : Terminal
- 2. F : Female
- 3. Plated
GB : Gold-Plated
- 4. Material
□ : Brass
P : Phosphor bronze

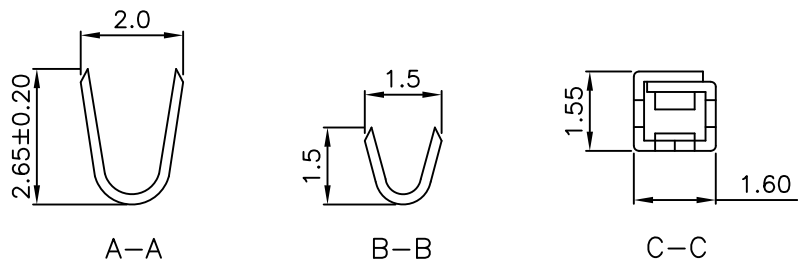

TOLERANCE					
X.	--	Young Yak Enterprise Co., Ltd. TITLE 2.54mm(.100") Pitch Wire to Board Terminal			
X.X	±0.20				
X.XX	±0.10				
X.XXX	±0.05				
ANGULAR	--				
APPROVALS					
DRAWN	Frank 03-JULY-2009	VIEW	SCALE	PART NO.	REV.
CHECKED	Denise 03-JULY-2009		F	YY-1800-TFGB*	A1
APPROVED	Jessica 03-JULY-2009	UNIT	SIZE	DWG NO.	SHEET
		MM	A4	YY-1800-TFGB*-014	1 OF 1



C **YI** US E182481

REV	DESCRIPTION	DATE

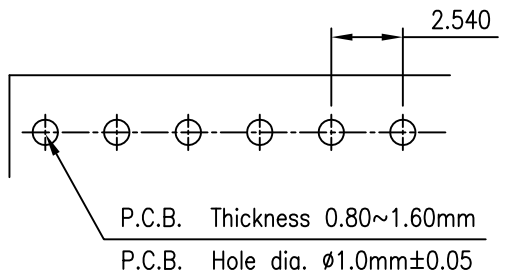
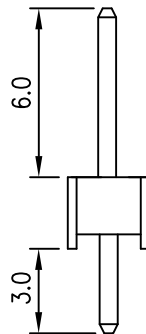
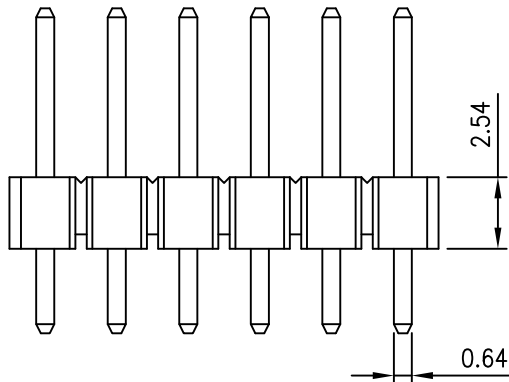
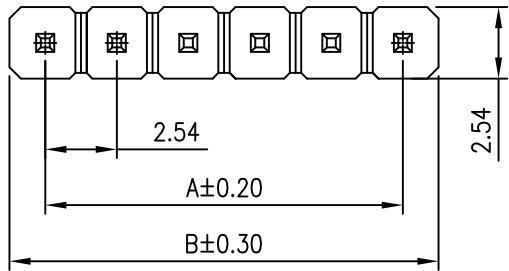

PCB LAOUT

Circuits	Dimension mm		
	A	B	
2	2.54	5.08	
3	5.08	7.62	
A: 2.54X(PART NO. OF PIN - 1)			
B: 2.54X(PART NO. OF PIN)			
40	99.06	101.6	

NOTES

Available in 02 through 40 Circuits
 Material: PBT UL94-V0 Glass Fiber Polyester
 Mates with 2.54mm(.100") Series Housing
 0.64mm(.025") Square Pin
 Pin Material: Brass/Gold-Plated or Tin-Plated

ORDERING INFORMATION

YY-1800 - W ** S *
 1 2 3

- No. of Circuits 02~40
- S : Straight
- Plated
 T : Tin
 G : Gold



TOLERANCE					
X.	--	TITLE 2.54mm(.100") Pitch Wire to Board Header			
X.X	±0.25				
X.XX	±0.15				
X.XXX	±0.05				
ANGULAR	--				
APPROVALS					
DRAWN	Frank	VIEW	SCALE	PART NO.	REV.
	19-September-2009		4:1	YY-1800-W***S*	A0
CHECKED	Denise	UNIT	SIZE	DWG NO.	SHEET
	19-September-2009	MM	A4	YY-1800-W***S*-153	1 OF 1
APPROVED	Jessica				
	19-September-2009				



C **YI** US E182481

REV	DESCRIPTION	DATE
A1	EN980831-1	2009.08.31

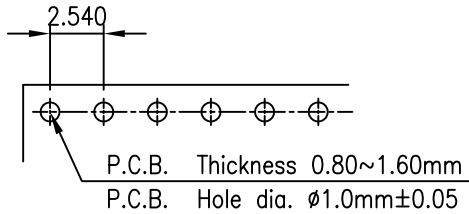
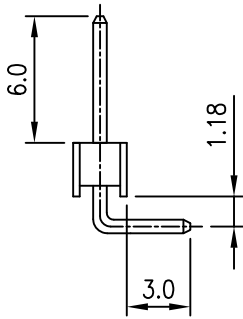
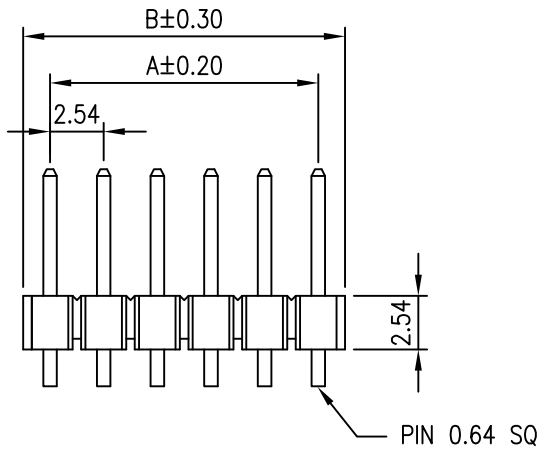
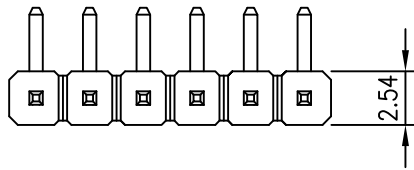

P.C.B. LAYOUT

Circuits	Dimension mm		
	A	B	
2	2.54	5.08	
3	5.08	7.62	
A: 2.54X(PART NO. OF PIN - 1)			
B: 2.54X(PART NO. OF PIN)			
40	99.06	101.6	

NOTES

Available in 02 through 40 Circuits
 Material: PBT UL94-V0 Glass Fiber Polyester
 Mates with 2.54mm(.100") Series Housing
 0.64mm(.025") Square Pin
 Pin Material: Brass/Gold-Plated or Tin-Plated

ORDERING INFORMATION

YY-1800 - W ** R *
 1 2 3

- No. of Circuits 02~40
- R : Right Angle
- Plated
 T : Tin
 G : Gold



TOLERANCE X. -- X.X ±0.25 X.XX ±0.15 X.XXX ±0.05 ANGULAR --		 Young Yak Enterprise Co., Ltd. TITLE 2.54mm(.100") Pitch Wire to Board Header		
APPROVALS DRAWN Frank 31-August-2009 CHECKED Denise 31-August-2009 APPROVED Jessica 31-August-2009				
		UNIT MM SIZE A4	DWG NO. YY-1800-W***R*-153	SHEET 1 OF 1



C **YI** US E182481

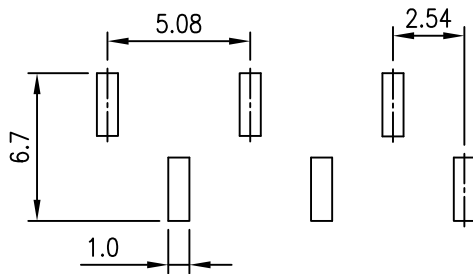
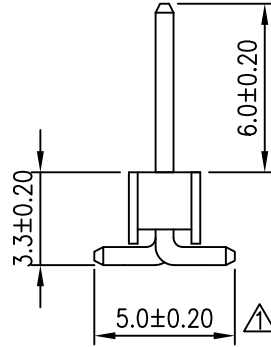
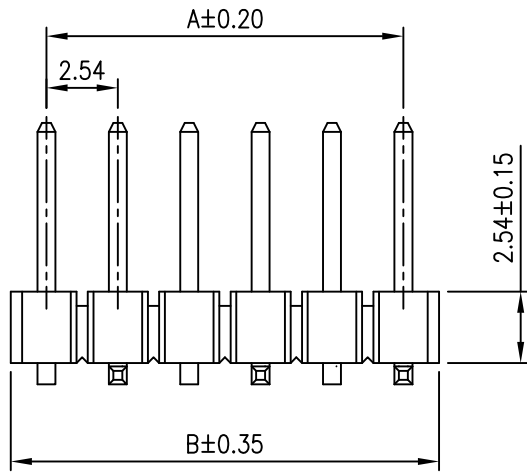
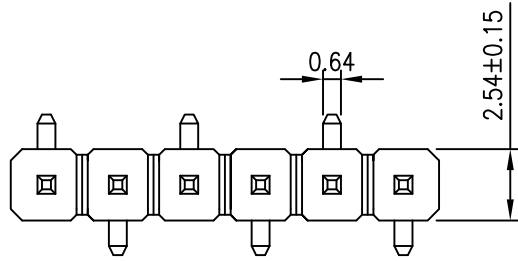

PCB LAYOUT

Circuits	Dimension mm		
	A	B	
2	2.54	5.08	
3	5.08	7.62	
A: 2.54X(PART NO. OF PIN - 1)			
B: 2.54X(PART NO. OF PIN)			
40	99.06	101.6	

REV	DESCRIPTION	DATE
A1	EN001130-2	2011.11.30

NOTES

Available in 02 through 40 Circuits
 Material: Nylon 6T UL94-V0
 Mates with YY-1800-H Series Housing
 0.64mm(.025") Square Pin
 Pin Material: Brass/Gold-Plated or Tin-Plated

ORDERING INFORMATION

YY-1800 - S ** S *
 1 2 3 4

- SMT
- No. of Circuits 02~40
- S : Straight
- Plated
 T : Tin
 G : Gold



Young Yak Enterprise Co., Ltd.

TITLE: 2.54mm(.100") Pitch
 Wire to Board Header

TOLERANCE				
X.	--			
X.X	±0.25			
X.XX	±0.15			
X.XXX	±0.05			
ANGULAR	--			
APPROVALS				
DRAWN	Frank	VIEW	SCALE	PART NO.
	30-November-2011		F	YY-1800-S**S*
CHECKED	Denise	UNIT	SIZE	DWG NO.
	30-November-2011	MM	A4	YY-1800-S**S*-153
APPROVED	Jessica			REV.
	30-November-2011			A1
				SHEET
				1 OF 1



C **YI** US E182481

REV	DESCRIPTION	DATE

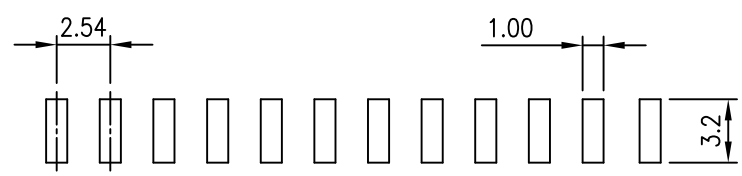
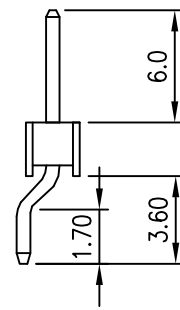
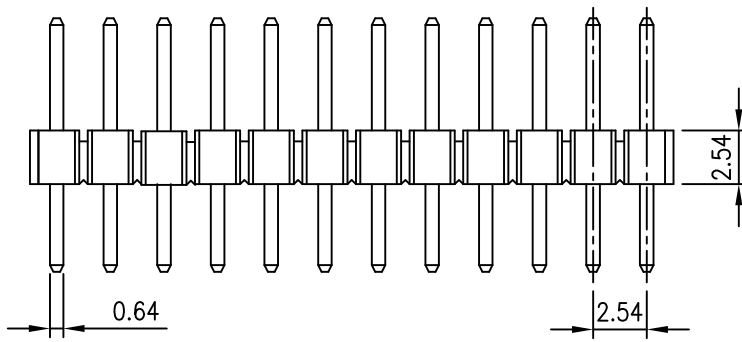
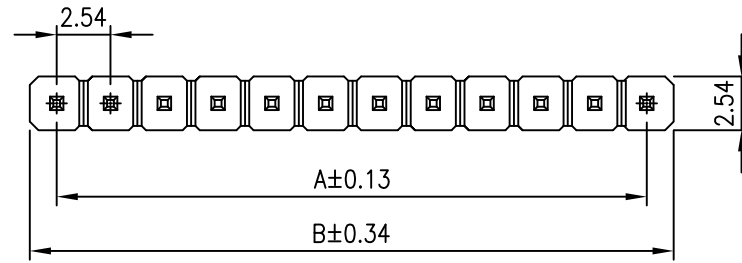

P.C.B. LAYOUT

Circuits	Dimension mm	
	A	B
2	2.54	5.08
3	5.08	7.62
A: 2.54X(PART NO. OF PIN - 1)		
B: 2.54X(PART NO. OF PIN)		
40	99.06	101.6

NOTES

Available in 02 through 40 Circuits
 Material: Nylon 6T UL94-V0
 Mates with 2.54mm(.100") Series Housing
 0.64mm(.025") Square Pin
 Pin Material: Brass/Gold-Plated or Tin-Plated

ORDERING INFORMATION

YY-1800 - S ** R *
 1 2 3 4

- S : SMT
- No. of Circuits 02~40
- R : Right angle
- Plated
 T : Tin
 G : Gold



TOLERANCE		Young Yak Enterprise Co., Ltd.			
X.	--	TITLE 2.54mm(.100") Pitch Wire to Board Header			
X.X	±0.25				
X.XX	±0.15				
X.XXX	±0.05				
ANGULAR	--				
APPROVALS					
DRAWN	Frank 30-JUNE-2009	VIEW	SCALE	PART NO.	REV.
CHECKED	Denise 30-JUNE-2009		F	YY-1800-S**R*	A0
APPROVED	Jessica 30-JUNE-2009	UNIT	SIZE	DWG NO.	SHEET
		MM	A4	YY-1800-S**R*-153	1 OF 1