

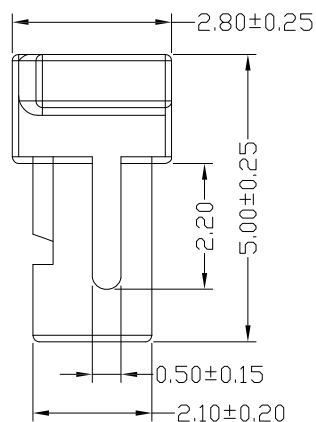

UL[®] US E182481

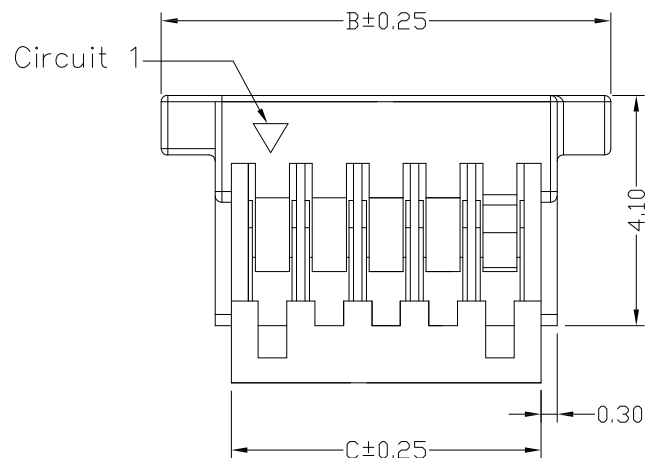
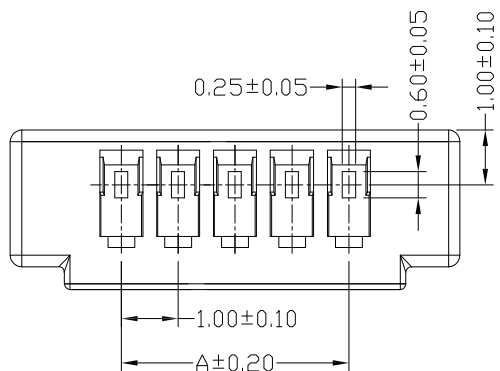

REV	DESCRIPTION	DATE

NOTES

Available in 02 through 24 Circuits
 Material: Nylon 66 UL94-V0 (Halogen Free)
 Accepts YY-0600-T Crimp Terminal
 Packing: 1,000 Pcs/Bag

SPECIFICATION

Voltage rating: 50V AC/DC
 Current rating: 1A AC/DC
 Dielectric Withstanding Voltage: 500V AC/minute
 Operation temperature: -25°C to +85°C
 Insulation Resistance: ≥100MΩ
 Contact resistance: ≤20mΩ
 After environmental testing: ≤30mΩ

YY-0600 - H ** N - HF
 1 2 3 4

- 1. H : Housing
- 2. No. of Circuits 02~24
- 3. N : Nylon 66 UL94-V0
- 4. HF : Halogen Free

Circuits	Dimension mm		
	A	B	C
2	1.00	5.00	2.40
3	2.00	6.00	3.40
4	3.00	7.00	4.40
5	4.00	8.00	5.40
6	5.00	9.00	6.40
7	6.00	10.00	7.40
8	7.00	11.00	8.40

Circuits	Dimension mm		
	A	B	C
9	8.00	12.00	9.40
10	9.00	13.00	10.40
11	10.00	14.00	11.40
12	11.00	15.00	12.40
13	12.00	16.00	13.40
14	13.00	17.00	14.40
15	14.00	18.00	15.40

Circuits	Dimension mm		
	A	B	C
16	15.00	19.00	16.40
17	16.00	20.00	17.40
18	17.00	21.00	18.40
19	18.00	22.00	19.40
20	19.00	23.00	20.40
22	21.00	25.00	21.40
24	23.00	27.00	22.40

TOLERANCE	
X.	--
X.X	±0.3
X.XX	±0.2
X.XXX	±0.1
ANGULAR	--
APPROVALS	
DRAWN	Kang
28-October-2014	
CHECKED	Denise
28-October-2014	
APPROVED	Jessica
28-October-2014	

Young Yak Enterprise Co., Ltd.

TITLE: 1.00mm(.039") Pitch Wire to Board Housing

VIEW	SCALE	PART NO.	REV.
	F	YY-0600-H**N-HF	A0
UNIT	SIZE	DWG NO.	SHEET
MM	A4	YY-0600-H**N-HF-217	1 OF 1





C US E182481

REV	DESCRIPTION	DATE

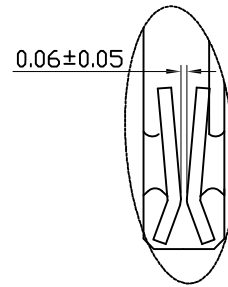
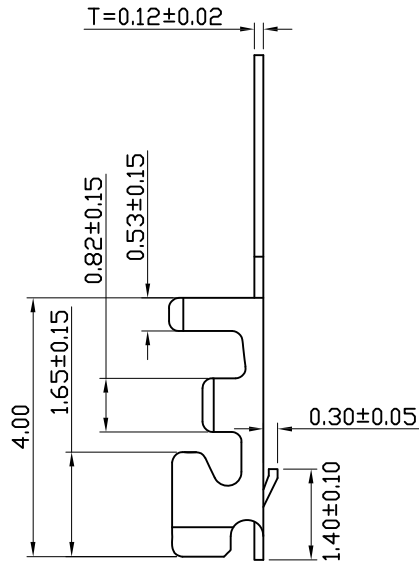
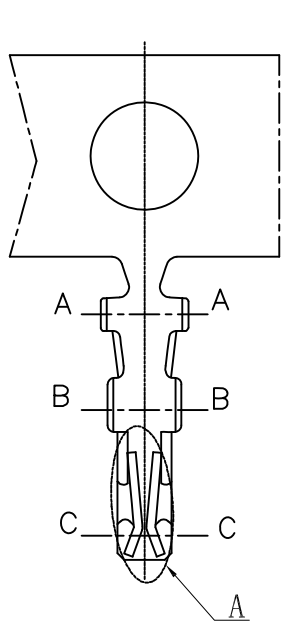

Scal A

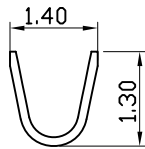

A-A

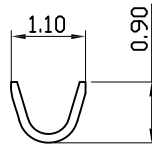

B-B

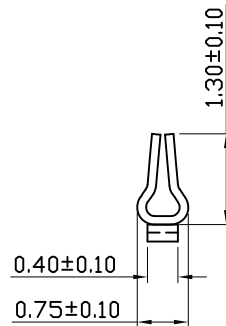

C-C

NOTES

Used in YY-0600-H Series Housing
 Accepts AWG #28~32 Wire Range
 Insulation O.D.= 0.92 mm Max.
 Material : Phosphor Bronze
 Finish : Tin-Plated
 Qty/Reel : 20,000 PCS
 Thickness: 0.12mm

SPECIFICATION

Voltage rating: 50V AC/DC
 Current rating: 1A AC/DC
 Dielectric Withstanding Voltage: 500V AC/minute
 Operation temperature: -25°C to +85°C
 Insulation Resistance: ≥100MΩ
 Contact resistance: ≤20mΩ
 After environmental testing: ≤40mΩ

ORDERING INFORMATION

YY-0600 - T TB P
 1 2 3

1. T : Terminal
2. Plated
TB : Tin-Plated
3. Material
P : Phosphor bronze



TOLERANCE					
X.	--	Young Yak Enterprise Co., Ltd. TITLE 1.00mm(.039") Pitch Wire to Board Terminal			
X.X	±0.30				
X.XX	±0.20				
X.XXX	±0.10				
ANGULAR	--				
APPROVALS					
DRAWN	Kang	VIEW	SCALE	PART NO.	REV.
	24-September-2014		F	YY-0600-TTBP	AO
CHECKED	Denise	UNIT	SIZE	DWG NO.	SHEET
	24-September-2014	MM	A4	YY-0600-TTBP-217	1 OF 1
APPROVED	Jessica				
	24-September-2014				



C **YI** US E182481

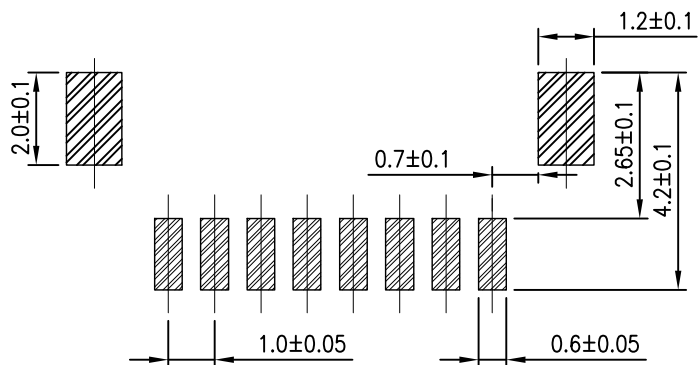
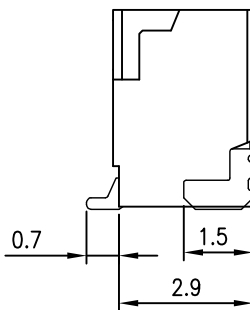
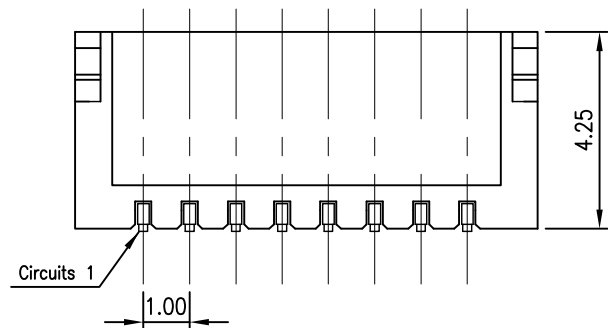
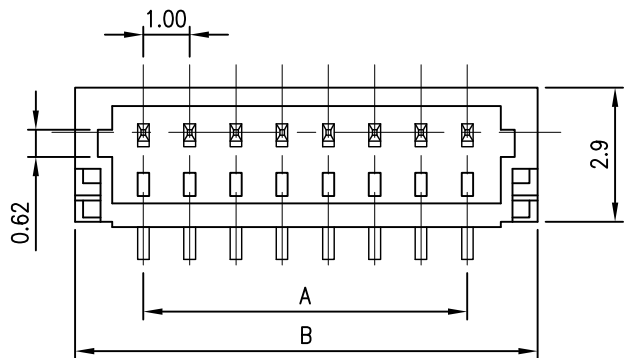

PCB LAYOUT

Circuits	Dimension mm		Circuits	Dimension mm	
	A	B		A	B
2	1.0	4.0	10	9.0	12.0
3	2.0	5.0	11	10.0	13.0
4	3.0	6.0	12	11.0	14.0
5	4.0	7.0	13	12.0	15.0
6	5.0	8.0	14	13.0	16.0
7	6.0	9.0	15	14.0	17.0
8	7.0	10.0	16	15.0	18.0
9	8.0	11.0	20	19.0	22.0

REV	DESCRIPTION	DATE
A1	EN980717-1	2009.07.17
A2	EN990310-1	2010.03.10
A3	EN000607-1	2011.06.07
A4	EN201410080001	2014.10.07

NOTES

Available in 02 through 20 Circuits
 Material: High Temperature Plastic UL94-V0
 Mates with YY-0600-H Series Single Row Housing
 Contact: Phosphor Bronze/Tin-Plated
 Color: Nature

ORDERING INFORMATION

⚠ YY-0600S - S ** S T *
 1 2 3 4 5

- S : SMT
- No. of Circuits 02~20
- S : Straight
- Plated
T : Tin-Plated
- Packing
A : Tape and Reel
B : Tube Package



TOLERANCE X. -- X.X ±0.25 X.XX ±0.15 X.XXX -- ANGULAR --				
APPROVALS DRAWN Kang 07-October-2014 CHECKED Denise 07-October-2014 APPROVED Jessica 07-October-2014		TITLE 1.00mm(.039") Pitch Wire to Board Header		
VIEW 	SCALE F	PART NO. YY-0600S-S**ST*	REV. A4	
UNIT MM	SIZE A4	DWG NO. YY-0600S-S**ST*-043	SHEET 1 OF 1	



C **YI** US E182481

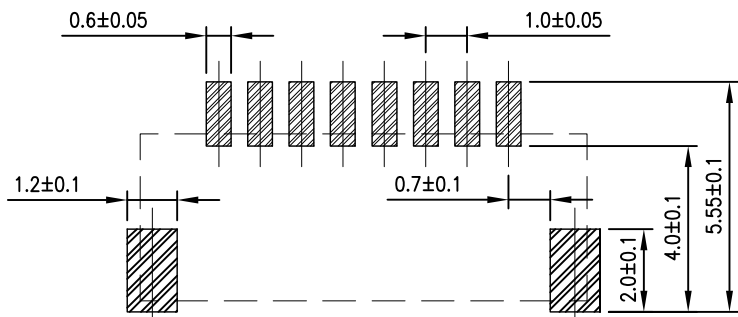
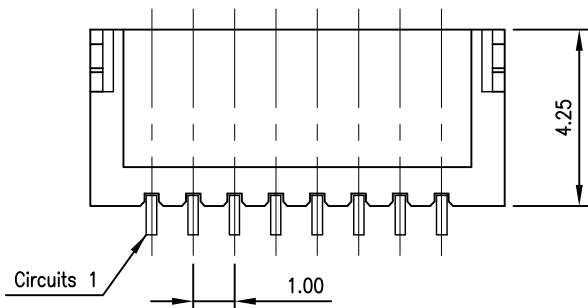
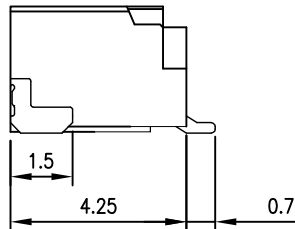
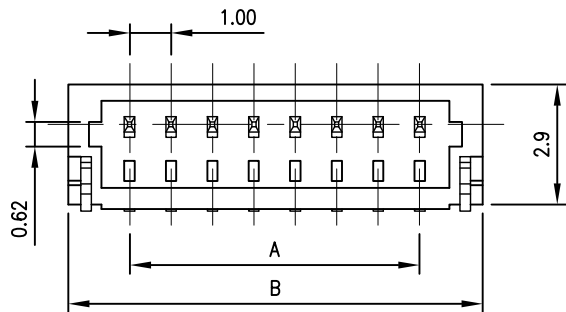

PCB LAYOUT



Circuits	Dimension mm		Circuits	Dimension mm	
	A	B		A	B
2	1.0	4.0	10	9.0	12.0
3	2.0	5.0	11	10.0	13.0
4	3.0	6.0	12	11.0	14.0
5	4.0	7.0	13	12.0	15.0
6	5.0	8.0	14	13.0	16.0
7	6.0	9.0	15	14.0	17.0
8	7.0	10.0	16	15.0	18.0
9	8.0	11.0	20	19.0	22.0

REV	DESCRIPTION	DATE
A1	EN980717-1	2009.07.17
A2	EN990310-1	2010.03.10
A3	EN201410080001	2014.10.07

NOTES

Available in 02 through 20 Circuits
 Material: High Temperature Plastic UL94-V0
 Mates with YY-0600-H Series Single Row Housing
 Contact: Phosphor Bronze/Tin-Plated
 Color: Nature

ORDERING INFORMATION

⚠ YY-0600S - S ** R T *
 1 2 3 4 5

- S : SMT
- No. of Circuits 02~20
- R : Right Angle
T : Tin
- Plated
A : Tape or Reel
B : Tube Package

TOLERANCE					
X.	--				
X.X	±0.25				
X.XX	±0.15				
X.XXX	--	TITLE 1.00mm(.039") Pitch Wire to Board Header			
ANGULAR	--	APPROVALS			
DRAWN	Kang	VIEW	SCALE	PART NO.	REV.
	07-October-2014		F	YY-0600S-S**RT*	A3
CHECKED	Denise	UNIT	SIZE	DWG NO.	SHEET
	07-October-2014	MM	A4	YY-0600S-S**RT*-043	1 OF 1
APPROVED	Jessica				
	07-October-2014				



C **YI** US E182481

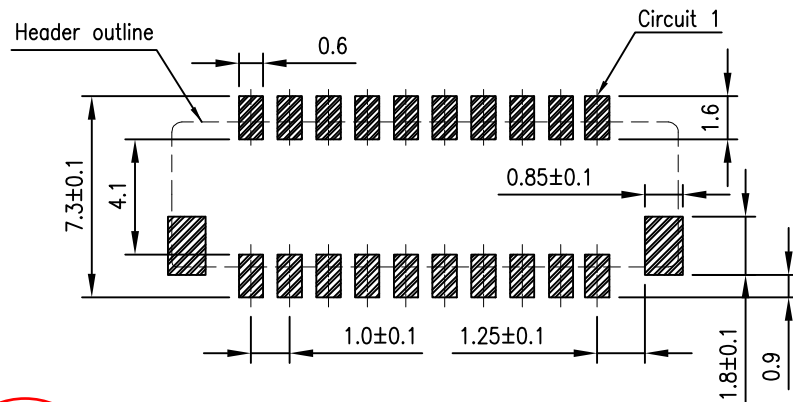
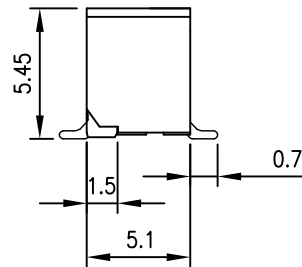
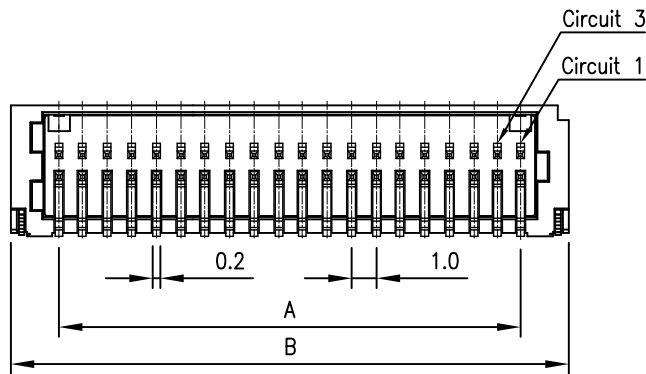
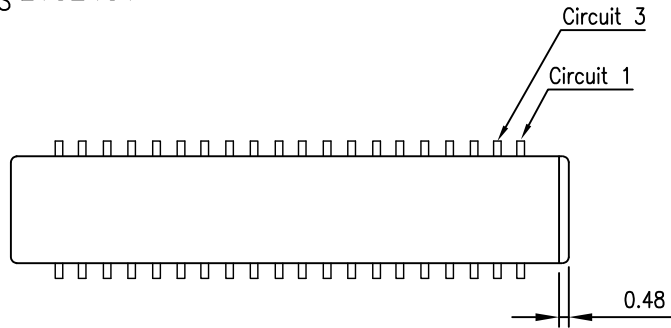

PCB LAYOUT

Circuits	Dimension mm	
	A	B
20	9.0	13.1
30	14.0	18.1
40	19.0	23.1
50	24.0	28.1

REV	DESCRIPTION	DATE
A1	EN990310-1	2010.03.10

NOTES

Material: Glass-filled polyamide UL94-V0
 Mates with YY-0600D-H Series Housing
 0.2mm(.008") Flat Pin
 Contact: Phosphor Bronze/Gold-Plated or Tin-Plated
 Tab: Brass/Tin-Plated
 Color: Nature

ORDERING INFORMATION

YY-0600D - S ** R * *
1 2 3 4 5

- S : SMT
- No. of Circuits 20,30,40,50
- R : Right Angle
- Plated
 G : Gold-Plated
 T : Tin-Plated
- Packing
 A : Tape & Reel
 B : Tube Package



TOLERANCE		Young Yak Enterprise Co., Ltd.			
X.	--	TITLE 1.00mm(.039") Pitch Wire to Board Header			
X.X	±0.30				
X.XX	±0.20				
X.XXX	--				
ANGULAR	--				
APPROVALS					
DRAWN	Frank	VIEW	SCALE	PART NO.	REV.
	10-March-2010		F	YY-0600D-S**R**	A1
CHECKED	Denise	UNIT	SIZE	DWG NO.	SHEET
	10-March-2010	MM	A4	YY-0600D-S**R**-043	1 OF 1
APPROVED	Jessica				
	10-March-2010				



C **YI** US E182481

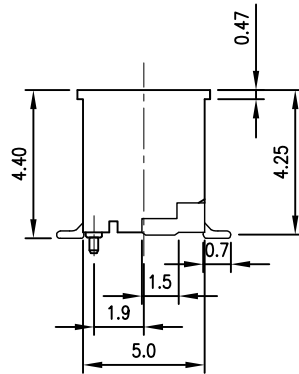
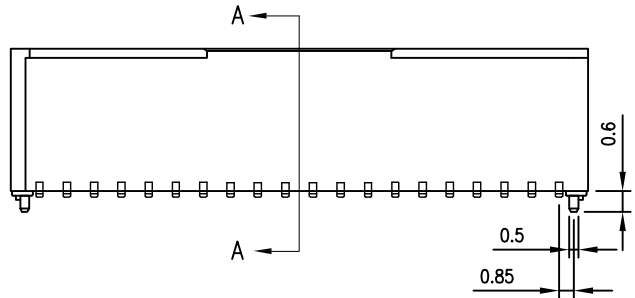
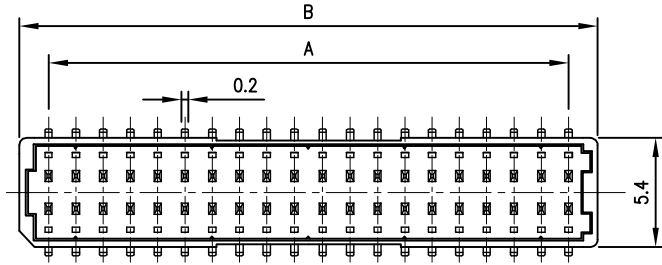

A-A

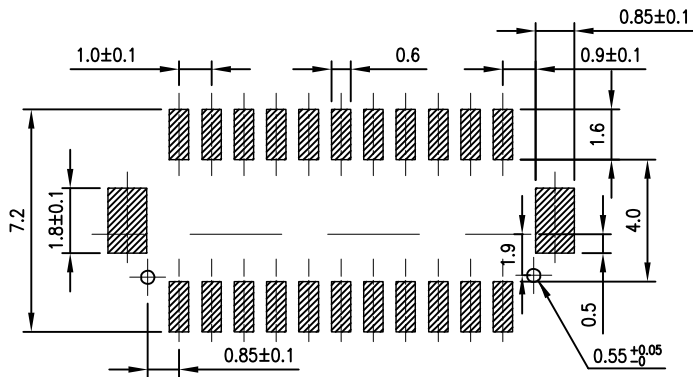
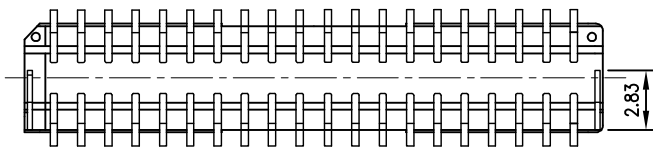

PCB LAYOUT

Circuits	Dimension mm	
	A	B
20	9.0	12.3
30	14.0	17.3
40	19.0	22.3
50	24.0	27.3

REV	DESCRIPTION	DATE
A1	EN990310-1	2010.03.10

NOTES

Available in 20 through 50 Circuits
 Material: Glass-filled polyamide UL94-V0
 Mates with YY-0600D-H Series Housing
 0.2mm(.008")Flat Pin
 Contact: Phosphor Bronze/Gold-Plated or Tin-Plated
 Tab: Brass/Tin-Plated
 Color: Nature

ORDERING INFORMATION

YY-0600D - S ** S * * *
 1 2 3 4 5 6

- S : SMT
- No. of Circuits 20~50
- S : Straight
- Plated
 G : Gold-Plated
 T : Tin-Plated
- : W/O Post
 P : W/Post
- Packing
 A : Tape & Reel
 B : Tube Package



Young Yak Enterprise Co., Ltd.

TITLE
 1.00mm(.039") Pitch
 Wire to Board Header

TOLERANCE				
X.	--			
X.X	±0.30			
X.XX	±0.20			
X.XXX	--			
ANGULAR	--			
APPROVALS				
DRAWN	Frank	VIEW	SCALE	PART NO.
	10-March-2010		F	YY-0600D-S**S***
CHECKED	Denise	UNIT	SIZE	DWG NO.
	10-March-2010	MM	A4	YY-0600D-S**S***-043
APPROVED	Jessica	REV.		
	10-March-2010	A0		
		SHEET		
		1 OF 1		