

Young Yak  
2012.09.20  
ISSUED

| REV | DESCRIPTION | DATE       |
|-----|-------------|------------|
| A1  | EN001107-1  | 2011.11.10 |
| A2  | EN010903-1  | 2012.09.03 |

**NOTES**

Material: Nylon 66 UL 94V-0 OR 94V-2  
 Available in 02 ~ 12 Circuits  
 Mates with : YY-5800-H\*\* , YY-5900-W\*\*  
 Single Row Connectors  
 Use with : YY-5700-T Terminals  
 Packing : Bag

**ORDERING INFORMATION**

YY - 5700 - H\*\* AS \* - \*\*\*  
                   1      2      3      4

- No. of Circuits : 02 ~ 12
- Housing Type  
AS : Single Row
- Material  
Q : Nylon 66 UL 94V-0  
□ : Nylon 66 UL 94V-2
- Housing Color  
□ : Nature  
116 : RAL(1016) Sulphur yellow  
314 : RAL(3014) Antique pink  
512 : RAL(5012) Light blue

| Part No.           | Circuits | A    | B    | Part No.           | Circuits | A    | B    |
|--------------------|----------|------|------|--------------------|----------|------|------|
| YY-5700-H02AS*-*** | 2        | 4.2  | 9.6  | YY-5700-H08AS*-*** | 8        | 29.4 | 34.8 |
| YY-5700-H03AS*-*** | 3        | 8.4  | 13.8 | YY-5700-H09AS*-*** | 9        | 33.6 | 39   |
| YY-5700-H04AS*-*** | 4        | 12.6 | 18   | YY-5700-H10AS*-*** | 10       | 37.8 | 43.2 |
| YY-5700-H05AS*-*** | 5        | 16.8 | 22.2 | YY-5700-H11AS*-*** | 11       | 42   | 47.4 |
| YY-5700-H06AS*-*** | 6        | 21   | 26.4 | YY-5700-H12AS*-*** | 12       | 46.2 | 51.6 |
| YY-5700-H07AS*-*** | 7        | 25.2 | 30.6 | ---                | ---      | ---  | ---  |

| TOLERANCE         |        |
|-------------------|--------|
| X.                | --     |
| X.X               | ±0.38  |
| X.XX              | ±0.25  |
| X.XXX             | ±0.10  |
| ANGULAR           | ±1°    |
| APPROVALS         |        |
| DRAWN             | Cherry |
| 03-September-2012 |        |
| CHECKED           | Kang   |
| 03-September-2012 |        |
| APPROVED          | Denise |
| 03-September-2012 |        |



| TITLE  |       |                   |        |
|--|-------|-------------------|--------|
| 4.20mm(.165") Pitch<br>RECEPTACLE SINGLE ROW |       |                   |        |
| VIEW   | SCALE | PART NO.          | REV.   |
|  | 2:1   | YY-5700-H**AS-*** | A2     |
| UNIT   | SIZE  | DWG NO.           | SHEET  |
| MM   | A4    | YY-5700-H**AS-014 | 1 OF 1 |



C US E182481

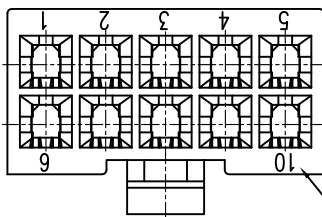

CIRCUIT NO.

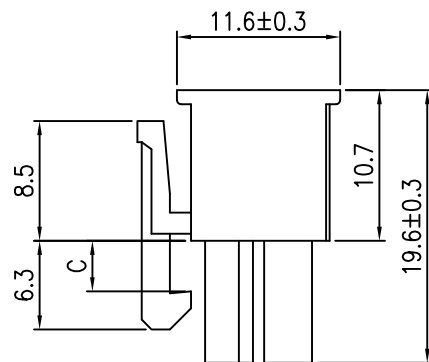
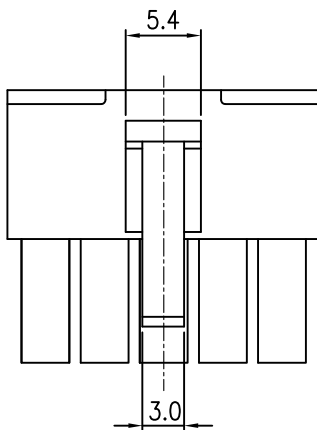
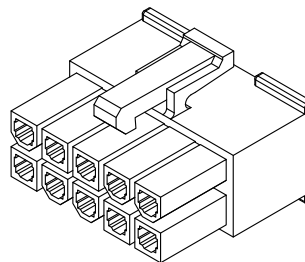

4~24 CIRCUIT

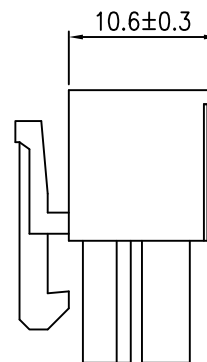

2 CIRCUIT

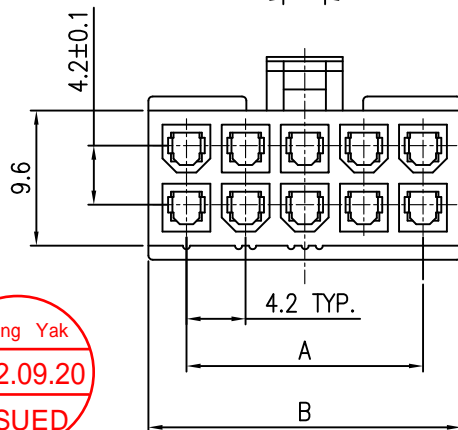

Young Yak  
2012.09.20  
ISSUED

**NOTES**

Body: Nylon 66 UL 94V-0 OR 94V-2  
 Color: Nature  
 Available in 02 ~ 24 Circuits  
 Mates with : YY-5800-H\*\* , YY-5900-W\*\*  
 Dual Row Connectors  
 Use with : YY-5700-T Terminals  
 Packing : Bag

**ORDERING INFORMATION**

YY - 5700 - H\*\* AD \* - \*\*\*  
 1 2 3 4

- No. of Circuits : 02 ~ 24
- Housing Type  
AD : Dual Row
- Material  
Q : Nylon 66 UL 94V-0  
□ : Nylon 66 UL 94V-2
- Housing Color  
□ : Nature  
116 : RAL(1016) Sulphur yellow  
314 : RAL(3014) Antique pink  
512 : RAL(5012) Light blue

| TOLERANCE         |        |
|-------------------|--------|
| X.                | --     |
| X.X               | ±0.38  |
| X.XX              | ±0.25  |
| X.XXX             | ±0.10  |
| ANGULAR           | ±1°    |
| APPROVALS         |        |
| DRAWN             | Cherry |
| 03-September-2012 |        |
| CHECKED           | Kang   |
| 03-September-2012 |        |
| APPROVED          | Denise |
| 03-September-2012 |        |



**Young Yak Enterprise Co., Ltd.**

| TITLE                                      |       |                    |        |
|--|-------|--------------------|--------|
| 4.20mm(.165") Pitch<br>RECEPTACLE DUAL ROW |       |                    |        |
| VIEW                                       | SCALE | PART NO.           | REV.   |
|  | 2:1   | YY-5700-H**AD*     | A1     |
| UNIT                                       | SIZE  | DWG NO.            | SHEET  |
| MM   | A4    | YY-5700-H**AD*-014 | 1 OF 2 |

| Part No.       | Circuits | A        | B        | C   | Part No.       | Circuits | A        | B        | C   |
|----------------|----------|----------|----------|-----|----------------|----------|----------|----------|-----|
| YY-5700-H02AD* | 2        | --       | 5.4±0.3  | 3.3 | YY-5700-H14AD* | 14       | 25.2±0.3 | 30.6±0.4 | 3.6 |
| YY-5700-H04AD* | 4        | 4.2±0.2  | 9.6±0.3  |     | YY-5700-H16AD* | 16       | 29.4±0.3 | 34.8±0.4 |     |
| YY-5700-H06AD* | 6        | 8.4±0.2  | 13.8±0.3 |     | YY-5700-H18AD* | 18       | 33.6±0.4 | 39.0±0.5 |     |
| YY-5700-H08AD* | 8        | 12.6±0.2 | 18.0±0.3 |     | YY-5700-H20AD* | 20       | 37.8±0.4 | 43.2±0.5 |     |
| YY-5700-H10AD* | 10       | 16.8±0.3 | 22.2±0.4 |     | YY-5700-H22AD* | 22       | 42.0±0.4 | 47.4±0.5 |     |
| YY-5700-H12AD* | 12       | 21.0±0.3 | 26.4±0.4 |     | YY-5700-H24AD* | 24       | 46.2±0.4 | 51.6±0.5 |     |

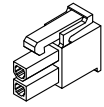

2 CIRCUIT

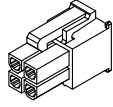

4 CIRCUIT

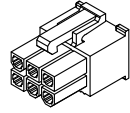

6 CIRCUIT

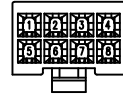
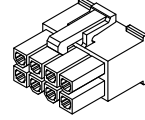

8 CIRCUIT

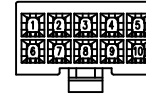
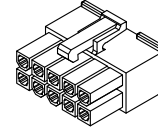

10 CIRCUIT

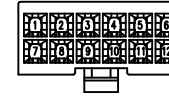
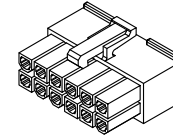

12 CIRCUIT

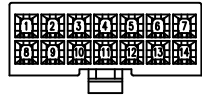
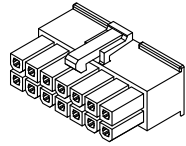

14 CIRCUIT

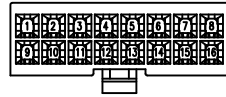
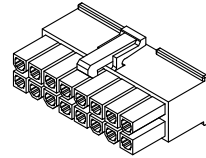

16 CIRCUIT

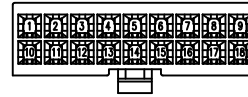
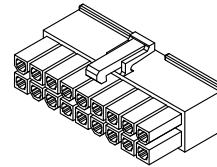

18 CIRCUIT

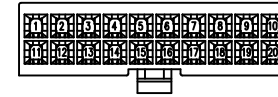
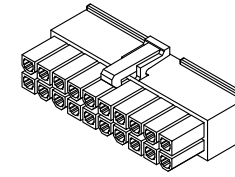

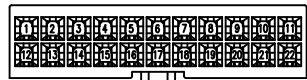
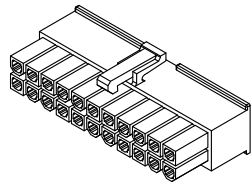

20 CIRCUIT

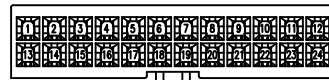
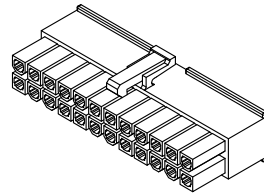

22 CIRCUIT



24 CIRCUIT

|           |                   |  |       |                    |        |
|-----------|-------------------|--|-------|--------------------|--------|
| TOLERANCE |                   |  <b>Young Yak Enterprise Co., Ltd.</b><br>TITLE<br>4.20mm(.165") Pitch<br>RECEPTACLE DUAL ROW |       |                    |        |
| X.        | --                |  |       |                    |        |
| X.X       | ±0.38             |  |       |                    |        |
| X.XX      | ±0.25             |  |       |                    |        |
| X.XXX     | ±0.10             |  |       |                    |        |
| ANGULAR   | ±1°               | APPROVALS  |       |                    |        |
| DRAWN     | Cherry            | VIEW   | SCALE | PART NO.           | REV.   |
|           | 03-September-2012 |   | F     | YY-5700-H**AD*     | A1     |
| CHECKED   | Kang              | UNIT   | SIZE  | DWG NO.            | SHEET  |
|           | 03-September-2012 | MM   | A4    | YY-5700-H**AD*-014 | 2 OF 2 |
| APPROVED  | Denise            |  |       |                    |        |
|           | 03-September-2012 |  |       |                    |        |



| REV | DESCRIPTION     | DATE       |
|-----|-----------------|------------|
| A2  | ECN-20138300001 | 2013.08.30 |

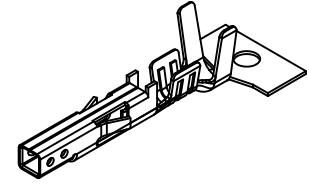
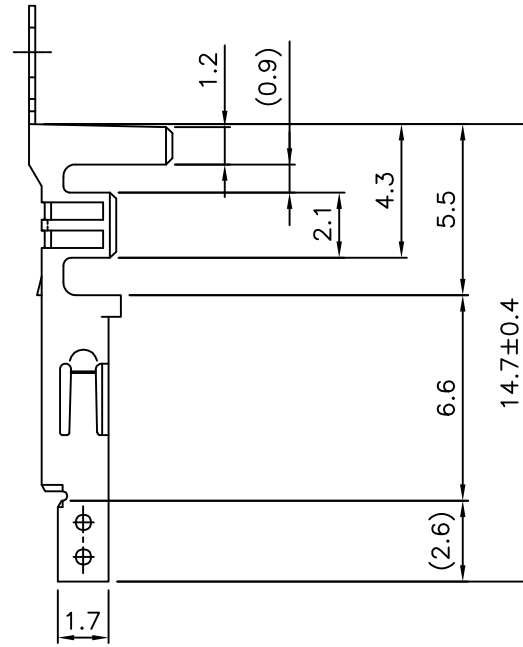
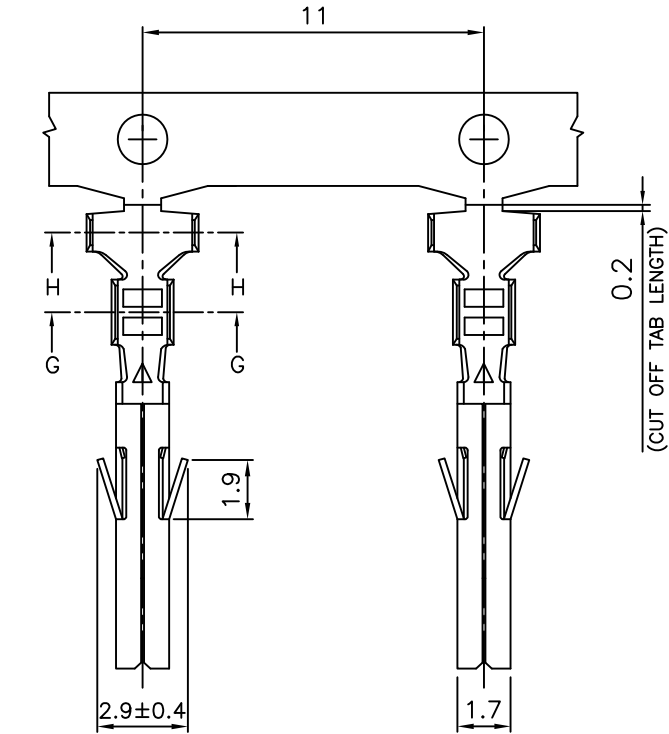

**NOTES**

Used in YY-5700-H Housing  
 Material : Brass or Phosphor Bronze  
 Finish : See Dimensions List  
 Thickness: 0.2mm

**ORDERING INFORMATION**

YY-5700 - T TA \* \*A \*  
                   1 2 3 4

1. PLATED & METHOD  
 TA : Tin , Pre-tinned
2. MATERIAL:  
 (SEE DIMENSIONS LIST)
3. WIRE RANGE  
 LA : AWG #16  
 MA : AWG #18-22  
 SA : AWG #22-26
4. SELECTIVE GOLD PLATED :  
 (SEE DIMENSIONS LIST)

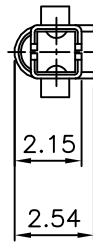
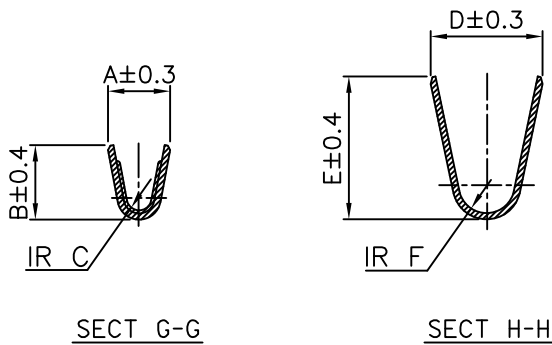

| TOLERANCE |       |
|-----------|-------|
| X.        | --    |
| X.X       | ±0.30 |
| X.XX      | ±0.25 |
| X.XXX     | ±0.20 |
| ANGULAR   | --    |



**Young Yak Enterprise Co., Ltd.**

TITLE  
 4.20mm(.165") Pitch  
 Power Connector Terminal



| APPROVALS |         | VIEW | SCALE | PART NO.           | REV.   |
|-----------|---------|------|-------|--------------------|--------|
| DRAWN     | Kang    |      | F     | YY-5700-TTA*A*     | A2     |
| CHECKED   | Denise  |      |       |                    |        |
| APPROVED  | Jessica | UNIT | SIZE  | DWG NO.            | SHEET  |
|           |         | MM   | A4    | YY-5700-TTA*A*-096 | 1 OF 3 |



DIMENSIONS LIST

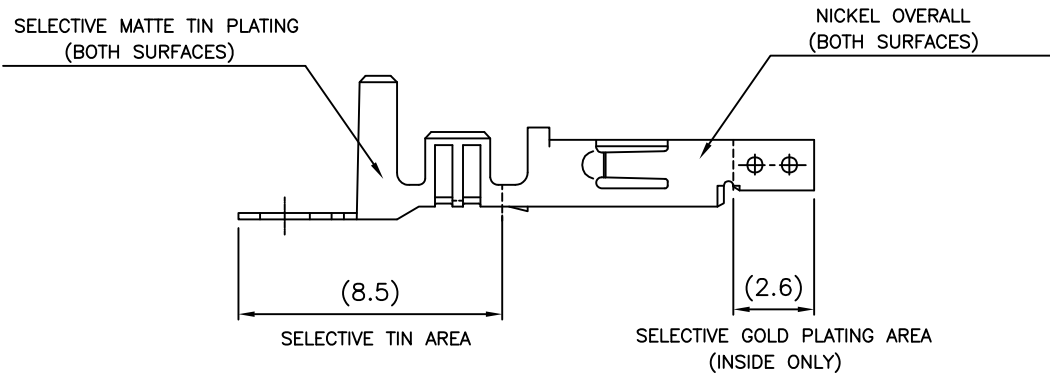

| MATERIAL | FINISH   | WIRE RANGE | INS.RANGE | A   | B    | C   | D   | E   | F   | PART NO.       |
|----------|--|------------|-----------|-----|------|-----|-----|-----|-----|----------------|
| BRASS    | TIN 100μ" All OVER NICKEL 30μ" PLATED<br>( Pre-tinned )                              | #16        | ø3.1 Max. | 2.3 | 2.7  | 0.6 | 3.6 | 4.5 | 0.9 | YY-5700-TTALA  |
|          |  | #18-22     | ø1.3-3.1  | 1.9 | 2.3  | 0.5 | 3.6 | 4.5 | 0.9 | YY-5700-TTAMA  |
|          |  | #22-26     | ø0.9-1.8  | 1.8 | 1.65 | 0.4 | 2.3 | 2.3 | 0.6 | YY-5700-TTASA  |
|          | SELECTIVE GOLD 1.2μ" & SELECTIVE TIN 100μ" OVER NICKEL 30μ" PLATED<br>( Pre-tinned ) | #16        | ø3.1 Max. | 2.3 | 2.7  | 0.6 | 3.6 | 4.5 | 0.9 | YY-5700-TTALA7 |
|          |  | #18-22     | ø1.3-3.1  | 1.9 | 2.3  | 0.5 | 3.6 | 4.5 | 0.9 | YY-5700-TTAMA7 |
|          |  | #22-26     | ø0.9-1.8  | 1.8 | 1.65 | 0.4 | 2.3 | 2.3 | 0.6 | YY-5700-TTASA7 |
|          | SELECTIVE GOLD 15μ" & SELECTIVE TIN 100μ" OVER NICKEL 30μ" PLATED<br>( Pre-tinned )  | #16        | ø3.1 Max. | 2.3 | 2.7  | 0.6 | 3.6 | 4.5 | 0.9 | YY-5700-TTALA8 |
|          |  | #18-22     | ø1.3-3.1  | 1.9 | 2.3  | 0.5 | 3.6 | 4.5 | 0.9 | YY-5700-TTAMA8 |
|          |  | #22-26     | ø0.9-1.8  | 1.8 | 1.65 | 0.4 | 2.3 | 2.3 | 0.6 | YY-5700-TTASA8 |
|          | SELECTIVE GOLD 30μ" & SELECTIVE TIN 100μ" OVER NICKEL 30μ" PLATED<br>( Pre-tinned )  | #16        | ø3.1 Max. | 2.3 | 2.7  | 0.6 | 3.6 | 4.5 | 0.9 | YY-5700-TTALA9 |
|          |  | #18-22     | ø1.3-3.1  | 1.9 | 2.3  | 0.5 | 3.6 | 4.5 | 0.9 | YY-5700-TTAMA9 |
|          |  | #22-26     | ø0.9-1.8  | 1.8 | 1.65 | 0.4 | 2.3 | 2.3 | 0.6 | YY-5700-TTASA9 |



|           |                |   |       |                    |        |
|-----------|----------------|---|-------|--------------------|--------|
| TOLERANCE |                |  <b>Young Yak Enterprise Co., Ltd.</b><br>TITLE<br>4.20mm(.165") Pitch<br>Power Connector Terminal |       |                    |        |
| X.        | --             |   |       |                    |        |
| X.X       | ±0.30          |   |       |                    |        |
| X.XX      | ±0.25          |   |       |                    |        |
| X.XXX     | ±0.20          |   |       |                    |        |
| ANGULAR   | --             |   |       |                    |        |
| APPROVALS |                |   |       |                    |        |
| DRAWN     | Kang           | VIEW  | SCALE | PART NO.           | REV.   |
|           | 30-August-2013 |    | F     | YY-5700-TTA*A*     | A2     |
| CHECKED   | Denise         | UNIT  | SIZE  | DWG NO.            | SHEET  |
|           | 30-August-2013 | MM  | A4    | YY-5700-TTA*A*-096 | 2 OF 3 |
| APPROVED  | Jessica        |   |       |                    |        |
|           | 30-August-2013 |   |       |                    |        |

DIMENSIONS LIST

| MATERIAL        | FINISH   | WIRE RANGE | INS.RANGE | A   | B    | C   | D   | E   | F   | PART NO.        |
|-----------------|--|------------|-----------|-----|------|-----|-----|-----|-----|-----------------|
| Phosphor Bronze | TIN 100μ" All OVER NICKEL 30μ" PLATED<br>( Pre-tinned )                              | #16        | ø3.1 Max. | 2.3 | 2.7  | 0.6 | 3.6 | 4.5 | 0.9 | YY-5700-TTAPLA  |
|                 |  | #18-22     | ø1.3-3.1  | 1.9 | 2.3  | 0.5 | 3.6 | 4.5 | 0.9 | YY-5700-TTAPMA  |
|                 |  | #22-26     | ø0.9-1.8  | 1.8 | 1.65 | 0.4 | 2.3 | 2.3 | 0.6 | YY-5700-TTAPSA  |
|                 | SELECTIVE GOLD 1.2μ" & SELECTIVE TIN 100μ" OVER NICKEL 30μ" PLATED<br>( Pre-tinned ) | #16        | ø3.1 Max. | 2.3 | 2.7  | 0.6 | 3.6 | 4.5 | 0.9 | YY-5700-TTAPLA7 |
|                 |  | #18-22     | ø1.3-3.1  | 1.9 | 2.3  | 0.5 | 3.6 | 4.5 | 0.9 | YY-5700-TTAPMA7 |
|                 |  | #22-26     | ø0.9-1.8  | 1.8 | 1.65 | 0.4 | 2.3 | 2.3 | 0.6 | YY-5700-TTAPSA7 |
|                 | SELECTIVE GOLD 15μ" & SELECTIVE TIN 100μ" OVER NICKEL 30μ" PLATED<br>( Pre-tinned )  | #16        | ø3.1 Max. | 2.3 | 2.7  | 0.6 | 3.6 | 4.5 | 0.9 | YY-5700-TTAPLA8 |
|                 |  | #18-22     | ø1.3-3.1  | 1.9 | 2.3  | 0.5 | 3.6 | 4.5 | 0.9 | YY-5700-TTAPMA8 |
|                 |  | #22-26     | ø0.9-1.8  | 1.8 | 1.65 | 0.4 | 2.3 | 2.3 | 0.6 | YY-5700-TTAPSA8 |
|                 | SELECTIVE GOLD 30μ" & SELECTIVE TIN 100μ" OVER NICKEL 30μ" PLATED<br>( Pre-tinned )  | #16        | ø3.1 Max. | 2.3 | 2.7  | 0.6 | 3.6 | 4.5 | 0.9 | YY-5700-TTAPLA9 |
|                 |  | #18-22     | ø1.3-3.1  | 1.9 | 2.3  | 0.5 | 3.6 | 4.5 | 0.9 | YY-5700-TTAPMA9 |
|                 |  | #22-26     | ø0.9-1.8  | 1.8 | 1.65 | 0.4 | 2.3 | 2.3 | 0.6 | YY-5700-TTAPSA9 |

|           |                           |   |       |                    |        |
|-----------|---------------------------|---|-------|--------------------|--------|
| TOLERANCE |                           |  <b>Young Yak Enterprise Co., Ltd.</b><br>TITLE<br>4.20mm(.165") Pitch<br>Power Connector Terminal |       |                    |        |
| X.        | --                        |   |       |                    |        |
| X.X       | ±0.30                     |   |       |                    |        |
| X.XX      | ±0.25                     |   |       |                    |        |
| X.XXX     | ±0.20                     |   |       |                    |        |
| ANGULAR   | --                        |   |       |                    |        |
| APPROVALS |                           |   |       |                    |        |
| DRAWN     | Kang<br>30-August-2013    | VIEW  | SCALE | PART NO.           | REV.   |
| CHECKED   | Denise<br>30-August-2013  |    | F     | YY-5700-TTA*A*     | A2     |
| APPROVED  | Jessica<br>30-August-2013 | UNIT  | SIZE  | DWG NO.            | SHEET  |
|           |                           | MM  | A4    | YY-5700-TTA*A*-096 | 3 OF 3 |



| REV | DESCRIPTION     | DATE       |
|-----|-----------------|------------|
| A2  | ECN-20138300001 | 2013.08.30 |

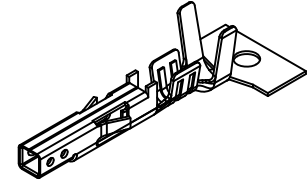
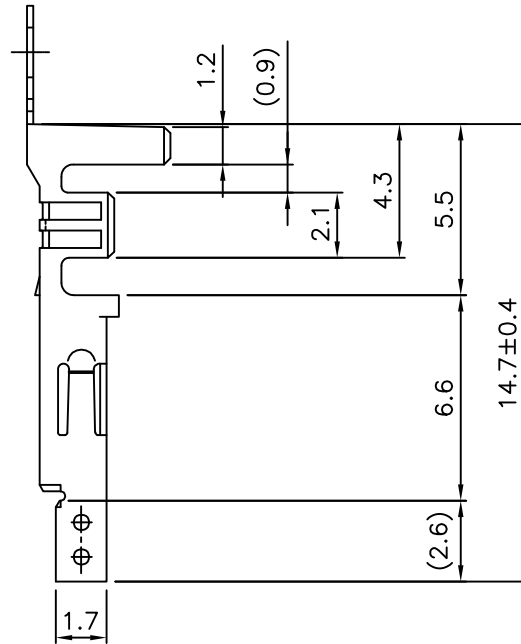
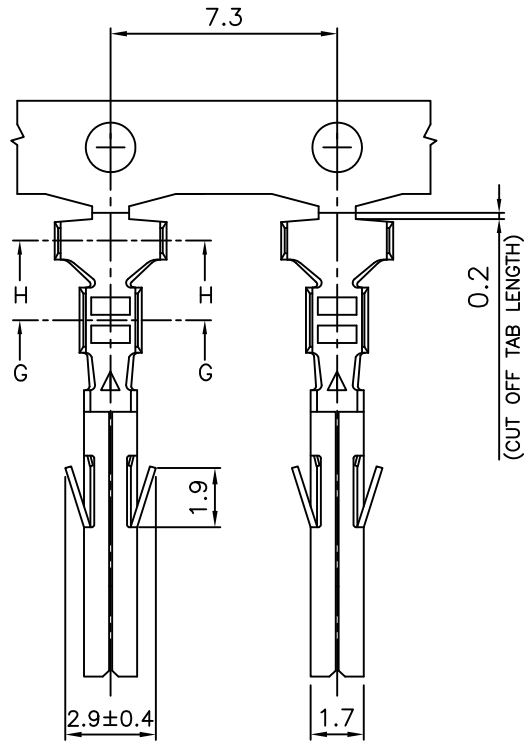

**NOTES**

Used in YY-5700-H Housing  
 Material : Brass or Phosphor Bronze  
 Finish : See Dimensions List  
 Thickness: 0.2mm

**ORDERING INFORMATION**

YY-5700 - T TA \* \*B \*  
                   1 2 3 4

1. PLATED & METHOD  
 TA : Tin , Pre-tinned
2. MATERIAL:  
 (SEE DIMENSIONS LIST)
3. WIRE RANGE  
 MB : AWG #18-22  
 SB : AWG #24-28
4. SELECTIVE GOLD PLATED :  
 (SEE DIMENSIONS LIST)

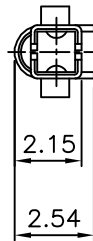
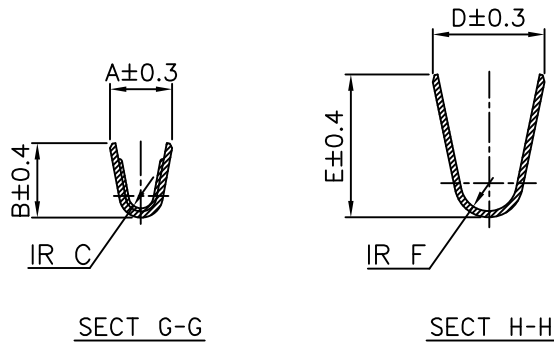

| TOLERANCE |       |
|-----------|-------|
| X.        | --    |
| X.X       | ±0.30 |
| X.XX      | ±0.25 |
| X.XXX     | ±0.20 |
| ANGULAR   | --    |



**Young Yak Enterprise Co., Ltd.**

TITLE  
 4.20mm(.165") Pitch  
 Power Connector Terminal



| APPROVALS |         | VIEW | SCALE | PART NO.           | REV.   |
|-----------|---------|------|-------|--------------------|--------|
| DRAWN     | Kang    |      | F     | YY-5700-TTA*B*     | A2     |
| CHECKED   | Denise  |      |       |                    |        |
| APPROVED  | Jessica | UNIT | SIZE  | DWG NO.            | SHEET  |
|           |         | MM   | A4    | YY-5700-TTA*B*-096 | 1 OF 2 |

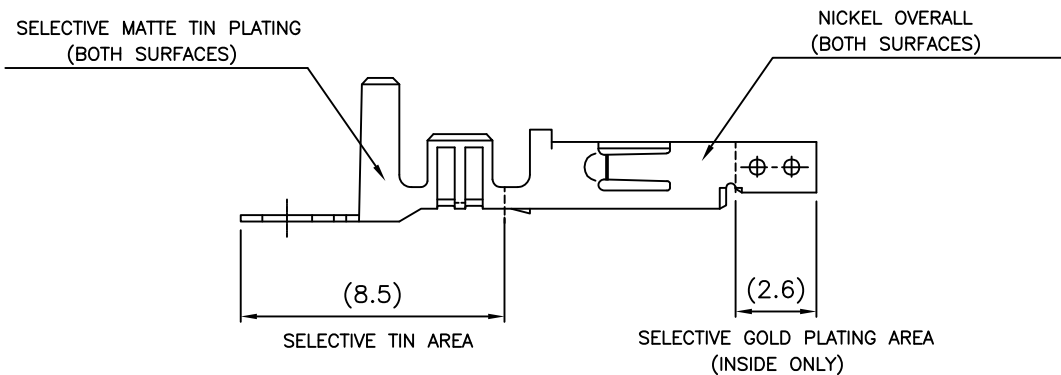

# DIMENSIONS LIST

| MATERIAL   | FINISH  | WIRE RANGE      | INS.RANGE       | A    | B    | C   | D   | E   | F               | PART NO.        |
|--|---|-----------------|-----------------|------|------|-----|-----|-----|-----------------|-----------------|
| BRASS  | TIN 100 $\mu$ " ALL OVER NICKEL 30 $\mu$ " PLATED<br>( Pre-tinned )                                       | #18-22          | $\phi$ 1.6-2.1  | 1.9  | 2.3  | 0.5 | 2.9 | 3.0 | 0.9             | YY-5700-TTAMB   |
|  |   | #24-28          | $\phi$ 1.2-1.45 | 1.8  | 1.65 | 0.4 | 2.3 | 2.3 | 0.6             | YY-5700-TTASB   |
|  | SELECTIVE GOLD 1.2 $\mu$ " & SELECTIVE TIN 100 $\mu$ "<br>OVER NICKEL 30 $\mu$ " PLATED<br>( Pre-tinned ) | #18-22          | $\phi$ 1.6-2.1  | 1.9  | 2.3  | 0.5 | 2.9 | 3.0 | 0.9             | YY-5700-TTAMB7  |
|  |   | #24-28          | $\phi$ 1.2-1.45 | 1.8  | 1.65 | 0.4 | 2.3 | 2.3 | 0.6             | YY-5700-TTASB7  |
|  | SELECTIVE GOLD 15 $\mu$ " & SELECTIVE TIN 100 $\mu$ "<br>OVER NICKEL 30 $\mu$ " PLATED<br>( Pre-tinned )  | #18-22          | $\phi$ 1.6-2.1  | 1.9  | 2.3  | 0.5 | 2.9 | 3.0 | 0.9             | YY-5700-TTAMB8  |
|  |   | #24-28          | $\phi$ 1.2-1.45 | 1.8  | 1.65 | 0.4 | 2.3 | 2.3 | 0.6             | YY-5700-TTASB8  |
| Phosphor Bronze  | TIN 100 $\mu$ " ALL OVER NICKEL 30 $\mu$ " PLATED<br>( Pre-tinned )                                       | #18-22          | $\phi$ 1.6-2.1  | 1.9  | 2.3  | 0.5 | 2.9 | 3.0 | 0.9             | YY-5700-TTAPMB  |
|  |   | #24-28          | $\phi$ 1.2-1.45 | 1.8  | 1.65 | 0.4 | 2.3 | 2.3 | 0.6             | YY-5700-TTAPSB  |
|  | SELECTIVE GOLD 1.2 $\mu$ " & SELECTIVE TIN 100 $\mu$ "<br>OVER NICKEL 30 $\mu$ " PLATED<br>( Pre-tinned ) | #18-22          | $\phi$ 1.6-2.1  | 1.9  | 2.3  | 0.5 | 2.9 | 3.0 | 0.9             | YY-5700-TTAPMB7 |
|  |   | #24-28          | $\phi$ 1.2-1.45 | 1.8  | 1.65 | 0.4 | 2.3 | 2.3 | 0.6             | YY-5700-TTAPSB7 |
|  | SELECTIVE GOLD 15 $\mu$ " & SELECTIVE TIN 100 $\mu$ "<br>OVER NICKEL 30 $\mu$ " PLATED<br>( Pre-tinned )  | #18-22          | $\phi$ 1.6-2.1  | 1.9  | 2.3  | 0.5 | 2.9 | 3.0 | 0.9             | YY-5700-TTAPMB8 |
|  |   | #24-28          | $\phi$ 1.2-1.45 | 1.8  | 1.65 | 0.4 | 2.3 | 2.3 | 0.6             | YY-5700-TTAPSB8 |
| SELECTIVE GOLD 30 $\mu$ " & SELECTIVE TIN 100 $\mu$ "<br>OVER NICKEL 30 $\mu$ " PLATED<br>( Pre-tinned ) | #18-22  | $\phi$ 1.6-2.1  | 1.9             | 2.3  | 0.5  | 2.9 | 3.0 | 0.9 | YY-5700-TTAPMB9 |                 |
|  | #24-28  | $\phi$ 1.2-1.45 | 1.8             | 1.65 | 0.4  | 2.3 | 2.3 | 0.6 | YY-5700-TTAPSB9 |                 |



| TOLERANCE |                |  <b>Young Yak Enterprise Co., Ltd.</b> |       |                    |        |
|-----------|----------------|---|-------|--------------------|--------|
| X.        | --             | TITLE<br>4.20mm(.165") Pitch<br>Power Connector Terminal  |       |                    |        |
| X.X       | $\pm$ 0.30     |   |       |                    |        |
| X.XX      | $\pm$ 0.25     |   |       |                    |        |
| X.XXX     | $\pm$ 0.20     |   |       |                    |        |
| ANGULAR   | --             |   |       |                    |        |
| APPROVALS |                |   |       |                    |        |
| DRAWN     | Kang           | VIEW  | SCALE | PART NO.           | REV.   |
|           | 30-August-2013 |                                        | F     | YY-5700-TTA*B*     | A2     |
| CHECKED   | Denise         | UNIT  | SIZE  | DWG NO.            | SHEET  |
|           | 30-August-2013 | MM  | A4    | YY-5700-TTA*B*-096 | 2 OF 2 |
| APPROVED  | Jessica        |   |       |                    |        |
|           | 30-August-2013 |   |       |                    |        |



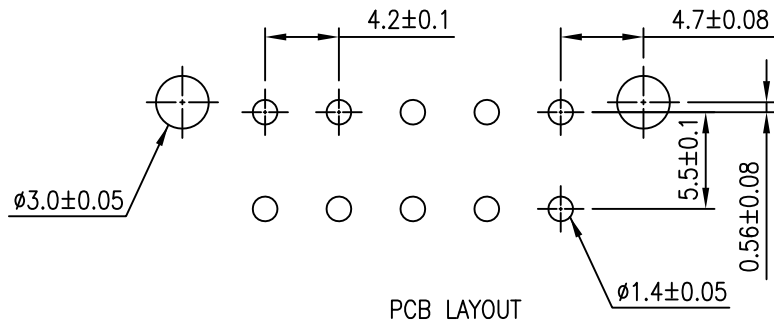
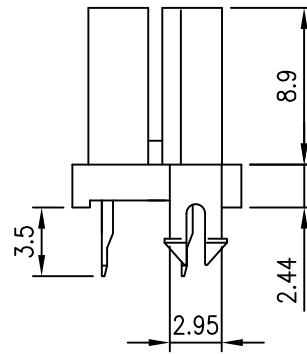
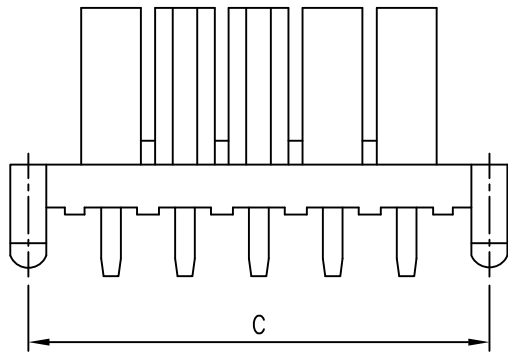
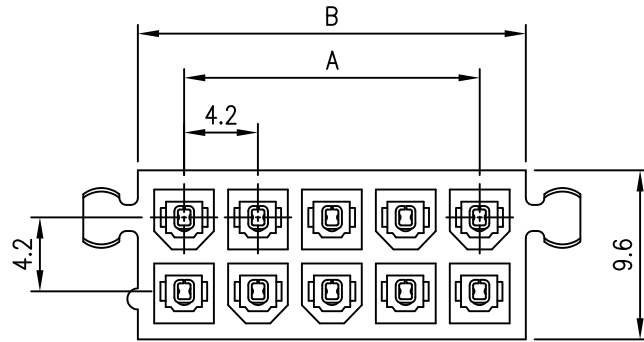

PCB LAYOUT

| Circuits                            | Dimension mm |      |      |
|-------------------------------------|--------------|------|------|
|                                     | A            | B    | C    |
| 2                                   | --           | 5.4  | 9.4  |
| A: 4.2 X (PART NO. OF PIN/2 -1)     |              |      |      |
| B: 4.2 X (PART NO. OF PIN/2 -1)+5.4 |              |      |      |
| C: 4.2 X (PART NO. OF PIN/2 -1)+9.4 |              |      |      |
| 24                                  | 46.2         | 51.6 | 55.6 |

| REV | DESCRIPTION | DATE |
|-----|-------------|------|
|     |             |      |

**NOTES**

Available in 2 Through 24 Circuits  
 Material: Nylon 66 UL94-V0  
 Pin Material: Brass/Tin-Plated

**ORDERING INFORMATION**

YY-5700 - W \*\* S T P  
                                   1 2 3 4

- No. of Circuits 02~24
- Contact Type  
S : Straight
- Plated  
T : Tin
- P : With Post

|  |       |  |        |  |
|--|-------|--|--------|--|
| <b>TOLERANCE</b><br>X. --<br>X.X ±0.40<br>X.XX ±0.25<br>X.XXX ±0.08<br>ANGULAR --  |       |  |        |  |
| <b>APPROVALS</b><br>DRAWN Frank<br>22-JANUARY-2009<br>CHECKED Denise<br>22-JANUARY-2009<br>APPROVED Jessica<br>22-JANUARY-2009 |       | <b>TITLE</b><br>4.2mm(.165") Pitch<br>Wire to Board Header |        |  |
| VIEW   | SCALE | PART NO.   | REV.   |  |
|  | F     | YY-5700-W**STP   | AO     |  |
| UNIT   | SIZE  | DWG NO.  | SHEET  |  |
| MM   | A4    | YY-5700-W**STP-085   | 1 OF 1 |  |

